

1 2 3 4 5 6 7 8 9

F
E
D
C
B
A

F
E
D
C
B
A

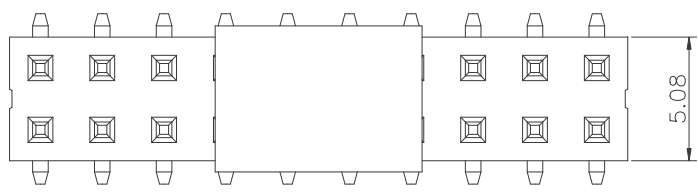

Specifications
 Current Rating:3.0Amp
 Insulation Resistance:1000MΩMin.
 Dielectric Withstanding Voltage:600VAC
 Contact Resistance:20mΩMax.
 Operating Temperature:-40°C to +105°C
 Materials
 Contact Material:
 Brass(Pin length less than 25mm)
 Phosphor Bronze(The total length of pin is more than 25mm)
 Insulator Material:
 Nylon(High temperature resistance),
 LCP(High temperature resistance),
 UL 94V-0
 All materials must meet Greenconn hazardous substances control standards.

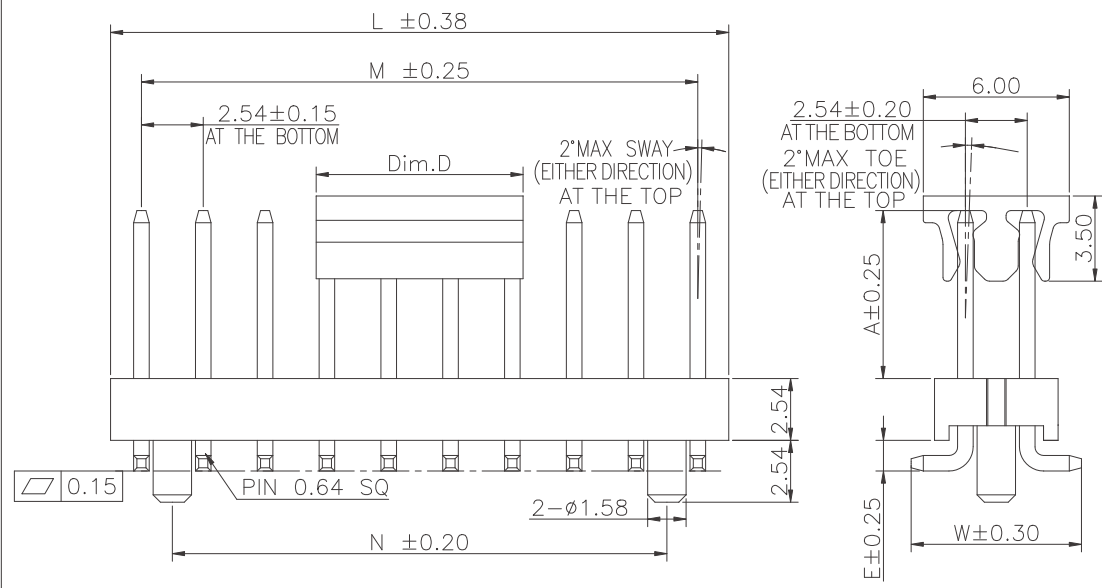

Recommended P.C.Board Layout
 (Tolerance:±0.05)

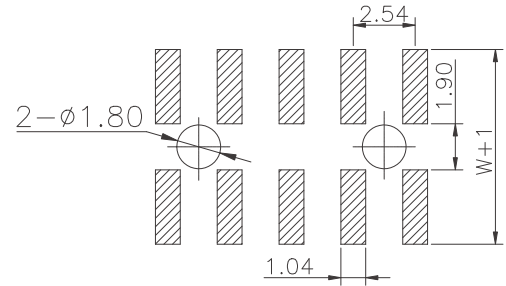

No. of PIN/ROW	Dimension Information		
	M	L	N
02	2.54	5.08	--
03	5.08	7.62	2.54
04	7.62	10.16	5.08
05	10.16	12.70	7.62
06	12.70	15.24	10.16
07	15.24	17.78	12.70
08	17.78	20.32	15.24
09	20.32	22.86	17.78
10	22.86	25.40	20.32
11	25.40	27.94	22.86
12	27.94	30.48	25.40
13	30.48	33.02	27.94
14	33.02	35.56	30.48
15	35.56	38.10	33.02
16	38.10	40.64	35.56
17	40.64	43.18	38.10
18	43.18	45.72	40.64
19	45.72	48.26	43.18
20	48.26	50.80	45.72
21	50.80	53.34	48.26
22	53.34	55.88	50.80
23	55.88	58.42	53.34
24	58.42	60.96	55.88
25	60.96	63.50	58.42
26	63.50	66.04	60.96
27	66.04	68.58	63.50
28	68.58	71.12	66.04
29	71.12	73.66	68.58
30	73.66	76.20	71.12
31	76.20	78.74	73.66
32	78.74	81.28	76.20
33	81.28	83.82	78.74
34	83.82	86.36	81.28
35	86.36	88.90	83.82
36	88.90	91.44	86.36
37	91.44	93.98	88.90
38	93.98	96.52	91.44
39	96.52	99.06	93.98
40	99.06	101.60	96.52

Ordering Information

XB-PZ-C-254-201

Plastic specifications
 1=Single row
 2=Dual row
 3=Tripe row
 4=Quadruple

Water code

Positioning column information
 A=No locating post
 B=Round post
 C=Square post

Pin length
 See the drawing

Color
 1=Black
 2=White
 3=Yellow
 E=Beige

Packing code
 A=Box
 B=Tray
 C=Tube
 D=Tape&Reel
 E=Cap+Tube
 F=Cap+Tape&Reel
 G=Acetate Tape+Tube
 H=Acetate Tape+Tape&Reel

No. of Pins per Row
 02~40

Plating code
 01=Tin
 02=Gold Flash
 05=Gold Flash/Tin
 22=Matte Tin

Insulator Material
 R=Nylon(Halogen Free)
 C=LCP

Contact Material
 A/S/K/T=Phosphor Bronze
 B/Z/H/W=Brass

Dim.D	NOTE
5.00mm	02pin
6.00mm	03~08pin
8.50mm	09~40pin

东莞市溪榜电子有限公司
 DONG GUAN XI BANG ELECTRONICS CO., LTD.
 Switch Connector

REV. 01 UNIT. mm SCALE. 4:1 PAGE. 1/1

GENERAL TOLERANCE	
X.*±5.0°	X.±0.30
.X*±3.0°	.X±0.25
.XX*±2.0°	.XX±0.15
.XXX*±1.0°	.XXX±0.10

DWG. NO.
XB-PZ-C-254-201

PART NO.
XB-PZ-C-254-201

TITLE.
**2.54 PIN HEADER
 DUAL ROWS SMT TYPE
 CONNECTOR**

1 2 3 4 5 6 7 8 9

1 2 3 4 5 6 7 8 9

Specifications

Current Rating : 3.0 Ampere
 Insulation Resistance : 1000 MΩ Min
 Dielectric Withstanding : 600V AC
 Contact Resistance : 20 mΩ Max
 Operating Temperature : -40°C to +105°C

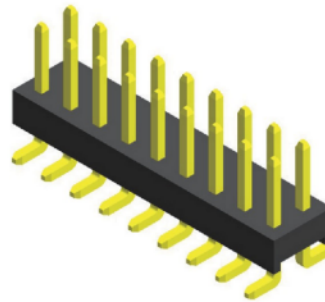

Materials

Contact Material : Brass
 Insulation Material : High Temperature Thermoplastic, 94V-0 Nylon

All materials must meet Greenconn's requirements for environmental protection.

Mating with

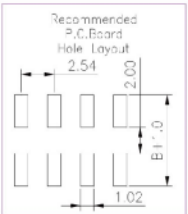
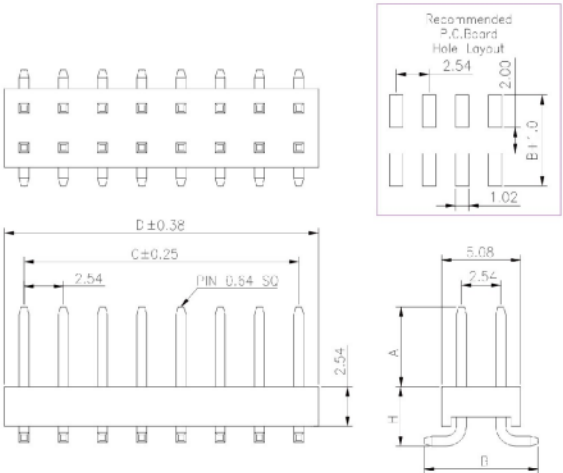
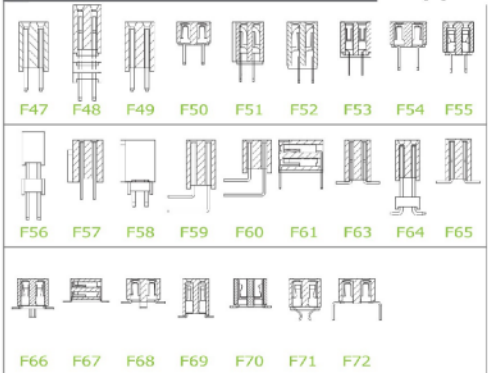

* For Coded Dimension Not Inside The Table, Please Refer To "Ordering Information"

No. of Pins/Row	Dimension Information		No. of Pins/Row	Dimension Information		No. of Pins/Row	Dimension Information		No. of Pins/Row	Dimension Information	
	C	D		C	D		C	D		C	D
02	2.54	5.08	11	25.40	27.94	21	50.80	53.34	31	76.20	78.74
03	5.08	7.62	12	27.94	30.48	22	53.34	55.88	32	78.74	81.28
04	7.62	10.16	13	30.48	33.02	23	55.88	58.42	33	81.28	83.82
05	10.16	12.70	14	33.02	35.56	24	58.42	60.96	34	83.82	86.36
06	12.70	15.24	15	35.56	38.10	25	60.96	63.50	35	86.36	88.90
07	15.24	17.78	16	38.10	40.64	26	63.50	66.04	36	88.90	91.44
08	17.78	20.32	17	40.64	43.18	27	66.04	68.58	37	91.44	93.98
09	20.32	22.86	18	43.18	45.72	28	68.58	71.12	38	93.98	96.52
10	22.86	25.40	19	45.72	48.26	29	71.12	73.66	39	96.52	99.06
			20	48.26	50.80	30	73.66	76.20	40	99.06	101.60

东莞市溪榜电子有限公司 DONG GUAN XI BANG ELECTRONICS CO., LTD. Switch Connector	GENERAL TOLERANCE		DESIGN:	DATE:	DWG. NO.	TITLE:
	REV. 01	UNIT. mm				

1 2 3 4 5 6 7 8 9