

Specifications
 Current Rating:1.0Amp
 Insulation Resistance:1000MΩMin.
 Dielectric Withstanding Voltage:300VAC
 Contact Resistance:20mΩMax.
 Operating Temperature:-40°C to +105°C
 Materials
 Contact Material:Phosphor Bronze
 Insulator Material:High Temperature Thermoplastic, UL 94V-0 LCP or the equivalent material
 All materials must meet Greenconn hazardous substances control standards.

Dim.D	NOTE
3.00mm	02~03pins
4.00mm	04~40pins

No. of PIN/ROW	Dimension Information	
	M	L
02	1.00	2.00
03	2.00	3.00
04	3.00	4.00
05	4.00	5.00
06	5.00	6.00
07	6.00	7.00
08	7.00	8.00
09	8.00	9.00
10	9.00	10.00
11	10.00	11.00
12	11.00	12.00
13	12.00	13.00
14	13.00	14.00
15	14.00	15.00
16	15.00	16.00
17	16.00	17.00
18	17.00	18.00
19	18.00	19.00
20	19.00	20.00
21	20.00	21.00
22	21.00	22.00
23	22.00	23.00
24	23.00	24.00
25	24.00	25.00
26	25.00	26.00
27	26.00	27.00
28	27.00	28.00
29	28.00	29.00
30	29.00	30.00
31	30.00	31.00
32	31.00	32.00
33	32.00	33.00
34	33.00	34.00
35	34.00	35.00
36	35.00	36.00
37	36.00	37.00
38	37.00	38.00
39	38.00	39.00
40	39.00	40.00

Ordering Information

XB-PZ-D-10-102

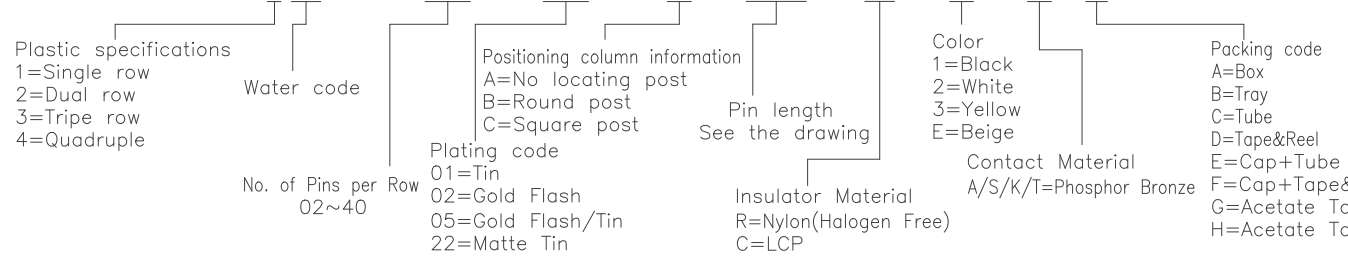

Recommended P.C.Board Layout

(Tolerance:±0.05)

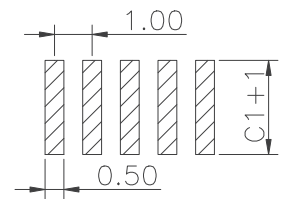

东莞市溪榜电子有限公司
 DONG GUAN XI BANG ELECTRONICS CO., LTD.
 Switch Connector

REV. 01 UNIT. mm SCALE. 5:1 PAGE. 1/1

GENERAL TOLERANCE	
X.*±5.0°	X.±0.30
.X*±3.0°	.X±0.25
.XX*±2.0°	.XX±0.15
.XXX*±1.0°	.XXX±0.10

DWG. NO.
XB-PZ-D-10-102

PART NO.
XB-PZ-D-10-102

TITLE.
**1.00 PIN HEADER
SINGLE ROW SMT TYPE
CONNECTOR**

1 2 3 4 5 6 7 8 9

Specifications

Current Rating : 1.0 Ampere
 Insulation Resistance : 1000 MΩ Min
 Dielectric Withstanding : 300V AC
 Contact Resistance : 20 mΩ Max
 Operating Temperature : -40°C to +105°C

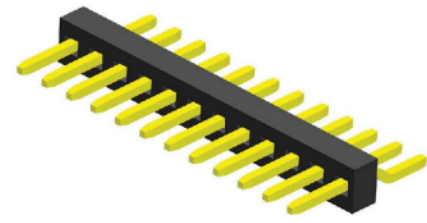

Materials

Contact Material : Phosphor Bronze
 Insulation Material : High Temperature Thermoplastic, 94V-0 LCP

All materials must meet Greenconn's requirements for environmental protection.

Mating with

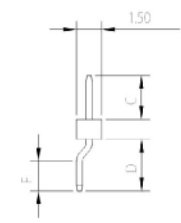
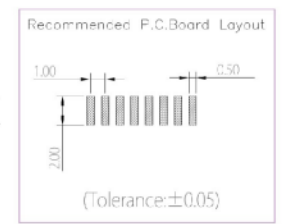
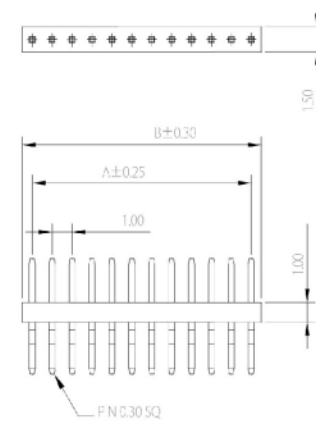
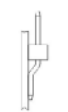
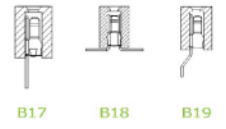

* For Coded Dimension Not Inside The Table, Please Refer To "Ordering Information"

No. of Pins/Row	Dimension Information		No. of Pins/Row	Dimension Information		No. of Pins/Row	Dimension Information		No. of Pins/Row	Dimension Information	
	A	B		A	B		A	B		A	B
02	1.00	2.00	11	10.00	11.00	21	20.00	21.00	31	30.00	31.00
03	2.00	3.00	12	11.00	12.00	22	21.00	22.00	32	31.00	32.00
04	3.00	4.00	13	12.00	13.00	23	22.00	23.00	33	32.00	33.00
05	4.00	5.00	14	13.00	14.00	24	23.00	24.00	34	33.00	34.00
06	5.00	6.00	15	14.00	15.00	25	24.00	25.00	35	34.00	35.00
07	6.00	7.00	16	15.00	16.00	26	25.00	26.00	36	35.00	36.00
08	7.00	8.00	17	16.00	17.00	27	26.00	27.00	37	36.00	37.00
09	8.00	9.00	18	17.00	18.00	28	27.00	28.00	38	37.00	38.00
10	9.00	10.00	19	18.00	19.00	29	28.00	29.00	39	38.00	39.00
			20	19.00	20.00	30	29.00	30.00	40	39.00	40.00

XB 东莞市溪榜电子有限公司
 DONG GUAN XI BANG ELECTRONICS CO., LTD.

REV. 01 UNIT. mm SCALE. 5:1 PAGE. 1/1

GENERAL TOLERANCE	
X. ±5.0'	X. ±0.30
.X' ±3.0'	.X ±0.25
.XX' ±2.0'	.XX ±0.15
.XXX' ±1.0'	.XXX ±0.10

DESIGN:	DATE:
CHECKED:	DATE:
AUDITED:	DATE:
APPROVED:	DATE:

DWG. NO. XB-PZ-D-10-102
 PART NO. XB-PZ-D-10-102

TITLE. 2.00 FEMALE HEADER SINGLE ROW DIP TYPE BASE 4.30H

1 2 3 4 5 6 7 8 9