

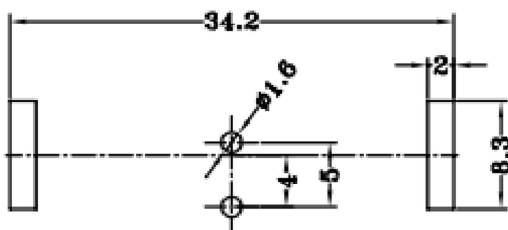

CAD FILE:

ROHS

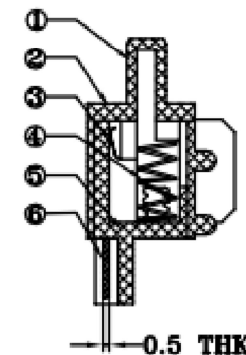
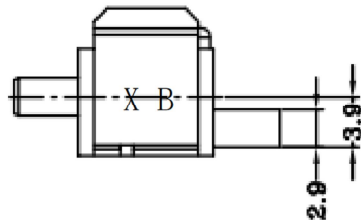
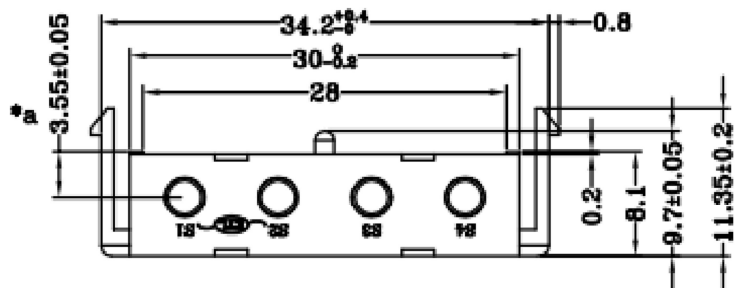
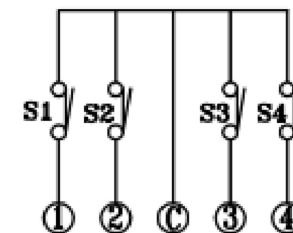
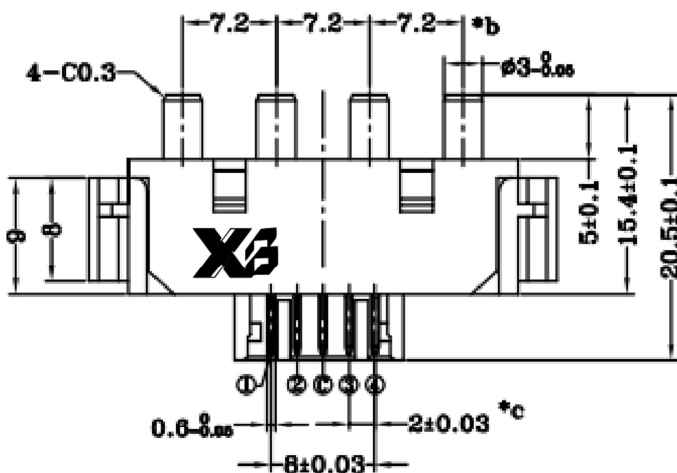
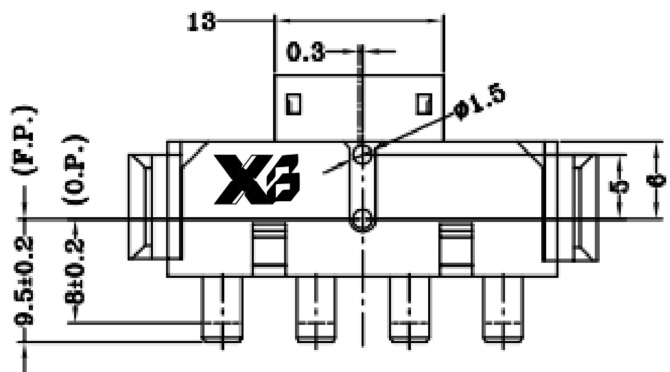

8					TOLERANCE				
7					UNLESS SPECIFIED				
6					WITHIN 1.5mm : ±0.1mm	A	2012-9-25	初版	ZENQ. CHEN
5					OVER 1.5mm : ±0.2mm	ISSUE	DATE	DESCRIPTIONS OF REVISION	APPD.
4	CONTACT	SUS	1	Ag CLAD	TITLE : Detector Switch			UNIT : mm	DRWG NO.: XB-SW4AG-554
3	CASE	PPA/BRASS SRTIP	1	BLACK/Ag PLATED	MODEL: XB-SW4AG-554			SCALE: 5:1	DWN. JUN. YANG 2012-9-25
2	COVER	STEEL STRIP	1	Ni PLATED	 东莞市溪榜电子有限公司 DONG GUAN XI BANG ELECTRONICS CO., LTD.			CHK'D	DONG. PANG 2012-9-25
1	KNOB	PPA	1	BLACK				APPD.	ZENQ. CHEN 2012-9-25
NO.	PARTS	MATERIALS	Q'TY	FINISH					