	产品型号 Product No. :	Microswitch Series	版本 VER	A/0
	产品料号 Part No. :		页码 Page	2 of 11
	文件编号 File No. :	WM-SP-0273	日期 Date	2017/02/25

### 1. 一般特性 General Characteristics:

1.1 适用范围 Application:	该规格书指微动开关的一般使用范围 This specification is applied to the micro switch for general Applications .
1.2 使用温度范围 Operating Temperature Range:	-25°C到+85°C -25°C to +85°C
1.3 相对湿度 Operating Relative Humidity:	≤85%RH, +5°C到+40°C ≤85% at +5°C to +40°C
1.4 保存温度范围 Storage Temperature Range	-25° C 到 +75° C -25° C to +75° C
1.5 实验条件 Test Conditions:	若没有特别说明, 则试验大气条件如下 Unless otherwise specified, the atmospheric conditions for making measurements and tests are as follows: 环境温度 Ambient Temperature: 5-35°C 大气压力 Air Pressure: 86-106Kpa 860-1060mbar 相对湿度 Relative Humidity: 25-85%RH

### 2. 外观, 结构及尺寸 Appearance, Structure & Dimensions:

2.1 外观 Appearance:	产品外观良好, 无锈蚀、裂纹和镀层缺陷。The switch shall have good finishing, and no rust, crack or plating defects.
2.2 结构及尺寸 Structure & Dimensions:	参见产品图纸。Refer to individual product drawing.
2.3 标识 (Markings):	参见产品图纸。Refer to individual product drawing.

### 3. 额定负荷 Ratings:

额定负荷 Ratings	3A/5A 12V/30V DC
--------------	------------------

### 4. 初始电气性能 Initial Electrical Characteristics:

项目 Item	标准 Criteria	实验方法 Test Method
4.1 接触电阻 Contact Resistance	30mΩ Max.	以 1A, 5V DC 或在 1KHz±200Hz (20mV Max, 50mA Max) 采用电压降法测量 Shall be measure at 1KHz±200Hz (20mV Max, 50mA Max) or 1A, 5V DC by voltage drop method.
4.2 绝缘电阻 Insulation Resistance	100MΩ Min.	在相互绝缘的所有端子之间及各接线端子与外露的非载流金属零件之间加载 500V 直流电, 持续时间 60±5 秒。 500V DC voltage is applied between each pair of terminals and between the terminal and the metal frame for 60±5Sec.
4.3 抗电强度 Dielectric Voltage	无击穿现象发生。 No dielectric breakdown shall occur.	在相互绝缘的所有接线端子之间加载 500V (50-60Hz, 泄漏电流 10mA) 交流电, 500V (50-60HZ, 10mA) alternate current load is applied between open terminals connected with wires. for 60±5Sec. 各接线端子与外壳或非载流金属零件之间加载 500V (50-60Hz, 泄漏电流 10mA) 交流电, 持续时间 60±5 秒。 500V (50-60HZ, 10mA ) alternate current load is applied between frame & terminal or between metal parts , for 60±5Sec.

	产品型号 Product No. :	Microswitch Series	版本 VER	A/0
	产品料号 Part No. :		页码 Page	3of 11
	文件编号 File No. :	WM-SP-0273	日期 Date	2017/02/25

### 5. 初始的机械特性 Initial mechanical Characteristics

项目 Item	标准 Criteria	实验方法 Test Method
5.1 操作力 Operating Force	参见产品图纸。 Refer to individual product drawing.	在操作元件末端沿操作方向均匀施加静载荷，使操作元件转换到动作位置 A static load shall be applied to the tip of actuator in operating direction to change the component to operating position
5.2 回复力 Releasing Force		在操作元件末端沿操作方向均匀减少静载荷，使操作元件从动作位置转换到释放位置 A static load shall be reduced to the tip of actuator in operating direction to change component from operating position to release position
5.3 自由位置 Free Position		开关自由状态时，操作元件末端到 PCB 表面的距离 When the switch is free, the operation element end to the surface of the printed to PCB distance
5.4 操作位置 Operation Position		开关发生转换时，操作元件末端到 PCB 表面的距离 When the switch switched on, the operation element end to the surface of the printed to PCB distance

### 6. 机械性能 Mechanical Characteristics

项目 Item	标准 Criteria	实验方法 Test Method
6.1 端子强度 Terminal Strength	实验后 After test: 电气和机械性能无异常。 Electrically and mechanically performances shall be satisfied.	以 500gf/5N 作用力沿轴向逐渐施加于接线端末端，作用力方向为离开开关向外方向，保持 5 秒，每个接线端子测量一次。 A static load of 500gf/5N shall be applied to the tip of terminal in a desired direction for 5 Sec. The test shall be done once per terminal.
6.2 振动试验 Vibration	实验后 After test: 电气和机械性能无异常。 Electrically and mechanically performances shall be satisfied.	开关采用常规的安装方法牢固地安装在试验设备上，并在下述参数条件下进行试验： Switch shall be secured to a testing machine by a normal mounting device and method. Switch shall be measured after following test. : (1) 振频 Vibration frequency range = 10-55 Hz (2) 振幅 Total amplitude = 1.5mm (3) 振动变化速率 Sweep ratio: 10-55-10Hz 大约 1 分钟 Approx. 1 min. (4) 变频方法：对数或线性形式 Method of changing the sweep vibration frequency: logarithmic or linear (5) 振动方向：三个相互垂直的方向，其中一个方向应是促动元件运动的方向 Direction of vibration: Three perpendicular directions including actuating direction. (6) 时间：每个方向 2 小时, 共 6 小时 Duration : 2 hours / direction , 6 hours in total

	产品型号 Product No. :	Microswitch Series	版本 VER	A/0
	产品料号 Part No. :		页码 Page	4of 11
	文件编号 File No. :	WM-SP-0273	日期 Date	2017/02/25

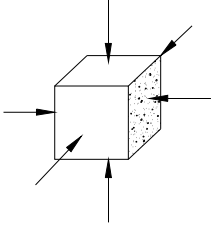
6.3	<p>冲击试验 Shock</p>	<p>实验后 After test: 电气和机械性能无异常。 Electrically and mechanically performances shall be satisfied.</p>	<p>试件在下述参数条件下进行试验: Switch shall be measured after following test: (1) 安装方法: 常规方法 Mounting Method: Normal (2) 加速度 Acceleration : <math>490m/s^2</math> (50G) (3) 时间 Duration : 11ms (4) 实验方向: 图示 6 方向 Test Direction : 6 directions (5) 冲击次数: 每个方向 3 次, 总共 18 次 Number of shocks : 3 times per direction ,18 times in total</p> 
6.4	<p>可焊性 Solder Ability</p>	<p>超过 90%的焊锡面积被焊料所覆盖。(断面除外) More than 90% of immersed part shall be covered with solder.</p>	<p>试件在下述参数条件下进行试验 Switch shall be checked after following test: (1) 焊料 Solder: Sn-3Ag-0.5Cu (2) 焊剂 Flux: Rosin Flux JIS K 5902 (3) 焊接温度: <math>245 \pm 3^{\circ}C</math> 焊接时间: <math>3 \pm 0.5</math> Sec Soldering Temperature: <math>245 \pm 3^{\circ}C</math> Immersing Time: <math>3 \pm 0.5</math> Sec</p>

	产品型号 Product No. :	Microswitch Series	版本 VER	A/0
	产品料号 Part No.		页码 Page	5of 11
	文件编号 File No. :	WM-SP-0273	日期 Date	2017/02/25

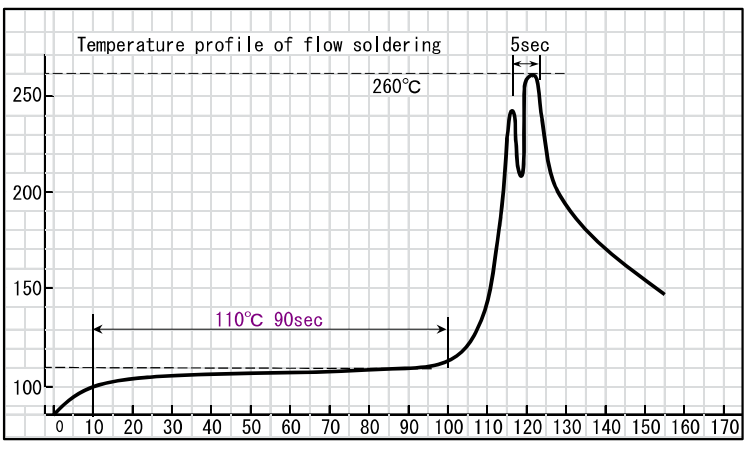
6.5	<p>耐焊接热 Solder Heat Resistance</p>	<p>实验后 After test: 电气和机械性能无异常。 Electrically and mechanically performances shall be satisfied.</p>	<p>试件按下述试验条件进行试验： Switch shall be tested according to the following request:</p> <p>(1) 无铅焊接温度及时间： 波峰焊：260° C Max, 5s Max.; 烙铁焊：350° C Max 2-3s (1) Soldering Temperature &amp; Immersing Time(tin/lead-free): Wave soldering: 260° C Max 5s Max Manual soldering: 350° C Max 2-3s</p> <p>(2) 焊料：Sn-3.0 Ag-0.5 Cu /无铅锡 (2) Solder: Sn-3.0 Ag-0.5 Cu tin/lead-free.</p> <p>(3) 焊剂：质量百分比为 25%松香，75%甲醇的无色透明溶液。 (3) Flux: Rosin Flux having a nominal composition of 25% solids by mass of water white rosin in methyl alcohol solution.</p> <p>(4) 深渍速度：25(±6) mm 每秒 (4) rate of immersion and emergence: 25(±6)mm, per second</p> <p>(5) 浸渍深度：在安装基准面的 1~1.5mm 以内 (5) Immersion Depth:The required depth of immersion is to within 1~1.5mm of the device body.</p> <p>(6) 试件按下述实验条件过一次波峰焊。 (6) The product should go through wave soldering for 1 times based on the following test condition.</p> <div data-bbox="766 1220 1516 1668">  <p>The graph shows a temperature profile for flow soldering. The y-axis represents temperature in degrees Celsius (100 to 250), and the x-axis represents time in seconds (0 to 170). The curve starts at 100°C, rises to a dwell at 110°C for 90 seconds, then rises to a peak of 260°C for 5 seconds, and finally cools down.</p> </div>
-----	--	---	--

	产品型号 Product No. :	Microswitch Series	版本 VER	A/0
	产品料号 Part No. :		页码 Page	6 of 11
	文件编号 File No. :	WM-SP-0273	日期 Date	2017/02/25

### 7. 寿命试验 Durability Characteristics

项目 Item	标准 Criteria	实验方法 Test Method
7.1 机械寿命 Operating Life without Load	实验后 After test: 接触电阻 Contact resistance : 5Ω Max 绝缘电阻 Insulation resistance: 10MΩMin. 操作力变化范围:	在不带负荷的条件下, 在寿命试验设备上以(6~10次 / 分)的速度连续转换 100,000 次。 100,000 cycles of operation shall be performed continuously at a rate of 6 to 10 cycles per minute with load as
7.2 电气寿命 Electronics Life	初期值±30% Operating force range: ±30% initial value 其它电气和机械性能无异常。 Electrically and mechanic performances shall be satisfied.	在带额定负荷的条件下, 在寿命试验设备连续转换 10,000 次, 6-10 次 / 分。 10,000 cycles of operation shall be performed continuously rate of 6-10 cycles per minute with load as follow:Rated L

### 8. 耐候性能 Weather Proof Characteristics:

项目 Item	标准 Criteria	实验方法 Test Method
8.1 低温 Cold Proof	实验后 After test: 电气和机械性能无异常。 Electrically and mechanically performances shall be satisfied.	试件在-25±2℃的温控箱内保持 96 小时, 然后在正常温度和湿度下恢复 1 小时, 并在此后 1 小时内对试品进行测量, 水滴应消失。 After testing at -25±2℃ for 96 hours , the switch shall be allowed to stand under normal temperature and humidity conditions for 1 hour, and measurement shall be made within 1 hour after that. Water drops shall be eliminated.
8.2 高温 Hot Proof	实验后 After test: 电气和机械性能无异常。 Electrically and mechanically performances shall be satisfied.	试件在 85±2℃的温控箱内保持 96 小时, 然后在正常温度和湿度下 1 小时, 并在此后 1 小时内对试品进行测量。 After testing at 85±2℃ for 96hours, the switch shall be allowed to stand under normal temperature and humidity conditions for 1 hour, and measurement shall be made within 1 hour after that.
8.3 恒定湿热 Moisture Resistance	实验后 After test: 电气和机械性能无异常。 Electrically and mechanically performances shall be satisfied.	试件在 40±2℃, 90-95%RH 的温控箱内保持 96 小时, 然后在正常温度和湿度下恢复 1 小时, 并在此后 1 小时内对试件进行测量, 水滴应消失。 After testing at 60±2℃ ,90-95% RH for 96 hours , the switch shall be allowed to stand under normal temperature and humidity conditions for 1 hour, and measurement shall be made within 1 hour after that. Water drops shall be eliminated.

	产品型号 Product No. :	Microswitch Series	版本 VER	A/0
	产品料号 Part No. :		页码 Page	7 of 11
	文件编号 File No. :	WM-SP-0273	日期 Date	2017/02/25

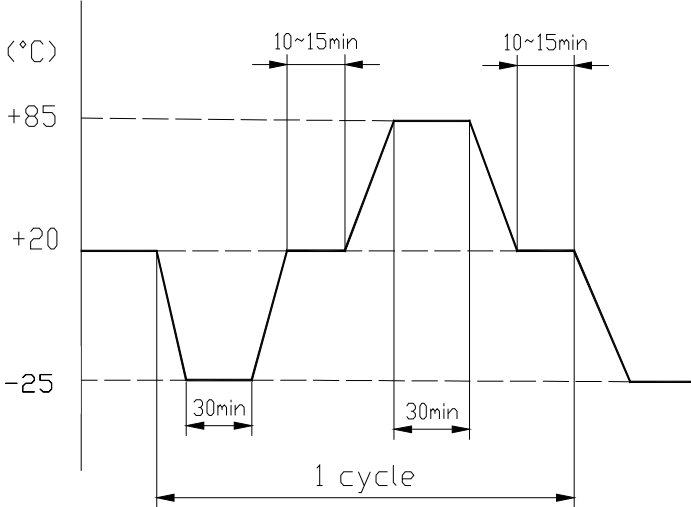
8.4	温度转换 Temperature Cycling	实验后 (After test): - 电气和机械性能无异常。 (Electrically and mechanically performances shall be satisfied.)	<p>试件按下述实验条件试验 5 个循环，然后在正常温度和湿度下恢复 1 小时，并在此后 1 小时内对试品进行测量，水滴应消失。          (After 5 cycles of following conditions, the switch shall be allowed to stand under normal temperature humidity conditions for 1 hour, and measurement shall be made within 1 hour after that. Water drops shall be eliminated.)</p>  <p>The graph illustrates one cycle of temperature cycling. The y-axis represents temperature in degrees Celsius (°C), with marked values at +85, +20, and -25. The x-axis represents time. The cycle starts at +20°C, ramps down to -25°C (labeled 10~15min), dwells at -25°C for 30min, ramps up to +85°C (labeled 10~15min), dwells at +85°C for 30min, ramps down to +20°C (labeled 10~15min), and dwells at +20°C for 30min. The total duration of one cycle is indicated as 1 cycle.</p>
-----	--------------------------------	--	--

#### 9. 备注 Remarks

若没有特殊要求，试验标准中的“电气和机械性能无异常”是指要求满足以下条件： Unless otherwise specified, The meaning of Electrically and mechanically performances shall be satisfied the following conditions in test standard:	
接触电阻 Contact Resistance	10Ω Max.
绝缘电阻 Insulation Resistance	10MΩ Min.
抗电强度 Dielectric Voltage	375V AC 1 分钟，无击穿现象发生。 375V AC for 1 minute Min. No dielectric breakdown.
操作力 Operating Force	弹力衰减小于 30%
其它 Other	开关的外观应无明显损坏。 The switch shall be free from abnormalities in appearance.

	产品型号 Product No. :	Microswitch Series	版本 VER	A/0
	产品料号 Part No. :		页码 Page	8of 11
	文件编号 File No. :	WM-SP-0273	日期 Date	2017/02/25

## 10. 注意事项 Precautions for use:

### 1. 一般事项 General:

本产品主要用于自动化装置，视像装置，家用电器，信息装置及通讯装置等常用电子设备中；如果该产品要用于其它具有更高安全性及可靠性的耐久性设备中（如生命维持装置，宇宙航空装置，防灾及安全性装置）时，请确认是否合用，或者同我方了解详细情况。

The product is used mainly in electronic devices such as automotive devices, visual devices, home electrical appliances, information devices and communication settings. If the products is intended to be used for other endurance equipments requiring higher safety and reliability such as life support system, space and aviation devices, disaster and safety system, it' s necessary to make verification of conformity or contact us for the details before using.

### 2. 焊接安装 Soldering and assembly:

(1) 如果焊锡时，有施力在端子部位的话，则端子可能会变形且易出现电气性能不良。

If there is force applied on the terminal during soldering, the terminal may deform and the electrical characteristics may not be satisfied.

(2) 焊锡条件应按照实际的对应条件予以确认。

The soldering conditions should be confirmed according to the actual production environment.

(3) 焊锡工序完成后，不要尝试用溶剂或类似物品清洗开关。

Don' t try to clean the switch with a solvent or similar substance after the soldering process.

(4) 开关焊锡后，还有热量时，请不要操作开关。

Don' t operate the switch if it still has heat after soldering.

(5) 如使用水溶性助焊剂，可能会导致开关破损，因此应确保不要用这种助焊剂。

The switch might be damaged if using the water-soluble flux, so make sure not to use such kind of flux.

### 3. 安装构造，机械设计 Assembly structure and Mechanical design:

(1) 线路上安装孔及安装图示的尺寸都须参照工程图中所建议的尺寸。

The dimensions for the holes and the pattern on PCB should refer to the recommended dimensions on the engineering drawing.

(2) 操作条件 Operating Conditions:

打键部件的许可倾斜角度为  $90 \pm 3^\circ$

The allowable inclination of keying section is  $90 \pm 3^\circ$  .

(3) 如果施超出规定值的较大重力于开关上，会导致开关破损，所以应特别小心防止开关承受超出规定值的较大重力。

The switch might be broken if there is stress stronger than the specified is given on it. Take special care not to stress the switch beyond its specification.

(4) 把本公司的产品和其它产品配合使用时，请客户确认必须适合的规格、法规或规定。另请客户自身确认本公司产品装到客户使用的系统、机械、装置上的适用性. 如果想变更开关使用条件，请预先与本公司进行协商。

If the switch is being used together other products, please confirm the compatibility of the specification, laws and regulations. Please also confirm the compatibility of switch to be



	产品型号 Product No. :	Microswitch Series	版本 VER	A/0
	产品料号 Part No. :		页码 Page	9 of 11
	文件编号 File No. :	WM-SP-0273	日期 Date	2017/02/25

installed in the systems, machines and devices used by customer. If you want to change the operating conditions of the switch, please consult with us in advance.

#### 4. 使用环境 Operating Environment

- (1) 如果该产品常用于产生硫化气体的硫性热源周围或有汽车废气存在的地方，应特别留意，因为开关性能可能会受到影响；

If the product is always used near sulfurate hot spring where sulfide gas is generated or in a place where exhaust gas from automobiles exists, it's necessary to pay more attention because the switch performance may be affected.

- (2) 如果在安装开关的模组内有以下所描述的部件材料，需遵循以下要求：

If the below parts or materials are used in the module where the switch is installed, directions below should be followed:

- A. 部品、橡胶材料、粘合剂、包装材料及用于装置内机械部件上的润滑油剂等，不要使用那些可能会产生硫化气体或氧化气体的材料。

For parts, rubber materials, adhesive agents, packing material and grease used for the mechanical part of the device, don't use any material that may generate gas of sulfurization or oxidization.

- B. 当有用到磷橡胶、润滑油、粘合剂及油脂时，应使用不会产生低分子磷氧烷气体的材料，因为低分子磷氧烷气体会在开关接触部位形成二氧化磷层而引起接触不良，如有用到（如涂料剂等化学溶剂），请预先告知我方。

If silicon rubber, grease, adhesive agents and oil are used, choose the material that will not generate low molecular siloxane gas, because the low molecular siloxane gas may form silicon dioxide coat on the switch contact part, resulting of failing contact.

- (3) 不要将开关用于高湿或有沾湿可能性的环境中，因这样的环境可能会引起端子间电流泄漏。

Don't use the switch in the environment with high humidity or other bedewing possibility, as it may cause leaking among the terminals.

- (4) 外部浸入物的影响 The effect caused by outer immersed dust:

由于该开关无密封机构，因此可能会由于外部环境中浸入的尘埃而引起接触失效，在使用该开关时，应采取防尘措施，以下是尘埃浸入的范例，使用时请注意防止：

Because the switch was designed without dust-proof structure, it may have failing contact due to the immersed dust from the outer environment. When using the switch, it's necessary to take dust-proof actions. Examples of immersed dust, which should be prevented during the operation:

- A. 加工过程中切口处及 PCB 孔处产生碎屑，或 PCB 防护材料，（如报纸、发泡、聚苯乙烯材料等）产生的废弃物等浸入开关内。

The scraps being generated during PCB processing, or other waste from the protective material for PCB such as newspaper, foam, polystyrene materials, may immerse inside the switch.

- B. 在堆叠 PCB 时产生的助焊剂或粉末状焊剂浸入开关内。

The flux or solder powder being generated when stacking the PCB may immerse inside the switch.

#### 5. 保存方法 Storage Method:

- (1) 为防止本产品的性能劣化和耐焊性等性能受到影响，请保管在以下的条件和环境下：

In order to protect the switch performance and the soldering conditions, it should keep the

	产品型号 Product No. :	Microswitch Series	版本 VER	A/0
	产品料号 Part No. :		页码 Page	10 of 11
	文件编号 File No. :	WM-SP-0273	日期 Date	2017/02/25

switch under the following conditions:

- ① 温度  $-10^{\circ}\text{C}$  以上,  $+40^{\circ}\text{C}$  以下, 湿度 85% 以下的环境。

Temperature of  $-10^{\circ}\text{C}$  to  $+40^{\circ}\text{C}$ , with humidity lower than 85%RH;

- ② 避免保存在含有腐蚀性气体等的空气中。

Avoid storing in the environment containing corrosive gas;

- ③ 避免保存在日光能直射的场所。

Avoid keeping it in the location with direct sunlight.

- (2) 在不施加负重外力的包装状态下进行保管, 自锁开关应是解锁状态下保存。

Store using the standard packing without exerting force, self-lock switch should be kept as released function.

- (3) 保存标准为 3 个月, 限度为 6 个月以内, 请尽早使用。打开包装后, 有剩余品时, 应将剩余部分以胶袋包装好以同外界隔离, 请进行合适的防湿, 防腐蚀气体等处理后进行保管。

The standard storage period is 3 months, with maximum up to 6 months, preferably to be used as soon as possible. After opening the package, you should put the remaining switches in a plastic bag to prevent from damp and corrosive gas.

## 6. 其它 Others

请特别注意严格遵守以下的禁止事项及注意事项:

Please take good care to comply with the following guidelines:

- (1) 关于火灾, 冒烟的禁止事项 The prohibited practices where there is fire and fume:

- ① 超过额定负荷使用时, 有发生火灾的可能性, 故请切勿超负荷使用。

It might catch fire if the rating exceeds the specifications. Never use the switch beyond the rating.

如果有误使用、异常使用等有可能超过额定电流的话, 请采取对策. 如: 通过设置保护电路等切断电流。

If the rating may exceed due to some abuse or abnormal usage, please take protective measures such as protective circuit to shut down the circuit.

- (2) 对于追求安全性产品的注意事项 Precautions to the products requiring special safety:

- ① 对于产品品质我司以期万全, 但有可能发生寿命等故障形式, 如性能劣化、短路、常开等。因此, 在设计追求安全性产品的时候: “对于零件单一故障, 产品会出现什么故障”。请进行事前检讨。

Though we are confident in switch quality, we can't deny the possibility that there could be failure due to inferior performance, short or open circuit. Therefore, when designing the product requiring special safety, please verify in advance what effects would show on your product in case the switch alone may fail.

- ② 准备保护电路、保护装置的系统以谋求安全。

Prepare the system with protective circuit and protective devices for safety purposes.

- ③ 准备安全备用电路, 使单一的故障不会导致整体系统的失效, 以确保安全性。

Prepare safety standby circuit to preclude the whole system failure that may result from specific failure.

	产品型号 Product No. :	Microswitch Series	版本 VER	A/0
	产品料号 Part No. :		页码 Page	11 of 11
	文件编号 File No. :	WM-SP-0273	日期 Date	2017/02/25

附注：操作参数示意图 (Remarks: The sketch for operating parameters)

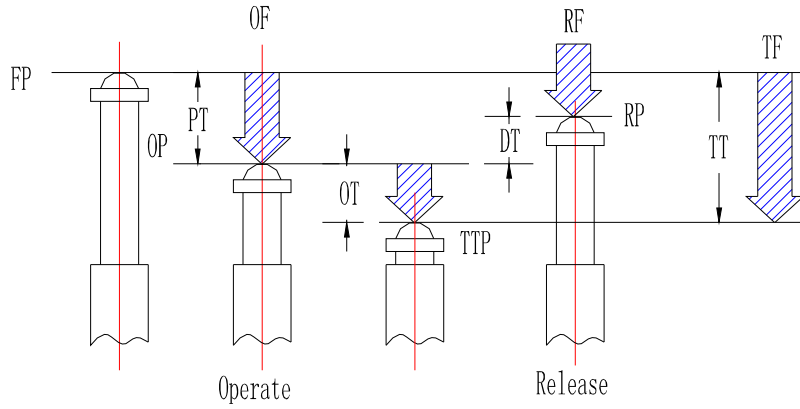

OF:操作力(Operating Force)  
RF:回复力(Release Force)  
TF:全行程力(Total travel Force)  
FP:自由位置(Free Position)  
OP:动作位置(Operating Position)  
TTP:全行程位置(Total Travel Position)  
RP:释放位置(Release Position)  
PT:接触行程(Pre Travel)  
OT:过行程(Over Travel)  
DT:差程(Differential Travel)  
TT:全行程(Total Travel)



# 东莞市溪榜电子有限公司

DONG GUAN XI BANG ELECTRONICS CO., LTD.

## PACKAGE STANDARD

TITLE : MICRO SWITCH

ISSUE : A

MODEL : XB-MX Series

### INNER PACKAGE LABEL

MODEL NO.	XB-MX-1381
QUANTITY	500 PCS
G.W./N.W.	/ KG
LOT NO.	
DATE	

PD06/B 06/2005

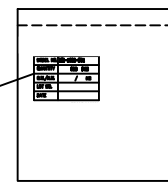

500 PCS/BAG

VINYLE WRAPPER

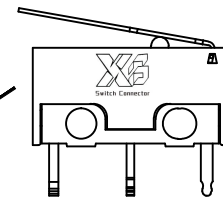

ONLY ONE BAG

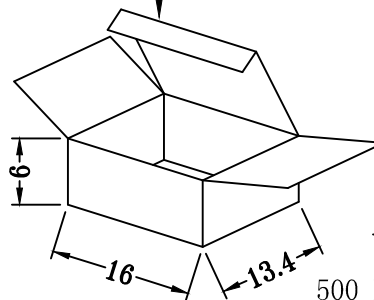

INNER BOX

500 PCS/INNER BOX

TOTAL 20 BOXES

### PACKAGE LABEL OF CARTONS

MODEL NO.	XB-MX-1381
QUANTITY	10000 PCS
LOT NO.	
DATE	
G.W./N.W.	/ KG
REMARK	

PD16/A 06/2005

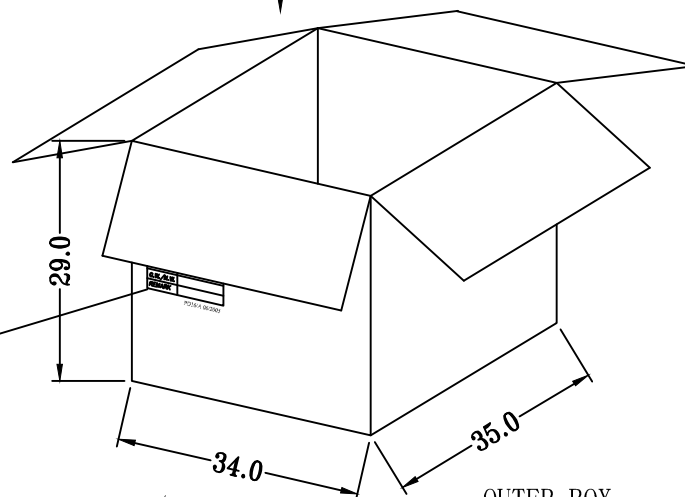

10000 PCS/OUTER BOX

OUTER BOX

### 说明:

1. 产品用PE袋放防潮珠封装(500PCS/包)、装纸盒(1包/盒)、装外箱(20盒/箱), 尾数箱取10或6盒外箱或用空盒填充, 封口包装时外箱不能变形.
2. 包装过程中, 防止产品受挤压变形, 外箱不能有破损封贴不严等现象.
3. 如客户有指定包装要求、侧按客户包装要求执行.

PREPARE

余文波

APPROVAL

陈远锋

DATE

1-Mar-2017